



# SyncServer S300

## High Performance, Enhanced Security GPS Network Time Server

### KEY FEATURES

- Ultra High-Bandwidth NTP Time Server
- Stratum 1 Operation via GPS Satellites
- Gigabit Ethernet Port plus 3 Additional Independent 10/100Base-T Ports
- Internal Dial-up Modem for Time Reference Redundancy
- Stratum 2 Operation via NTP Servers
- RADIUS, NTPv4 Autokey, MD5 Authentication
- Secure Web-Based Management
- SSH, SSL, SCP, SNMP, Custom MIB, HTTPS, Telnet, and More
- High-Resolution Vacuum Fluorescent Display
- Full Numeric Keypad
- IPv6 and IPv4 Compatible
- Nanosecond Time Accuracy to UTC
- Dedicated Sysplex Timer Output
- Alarm Relays
- Single Satellite Timing
- Rubidium & OCXO Oscillator Upgrades
- Upgrade to Radio Broadcast Time Sync

### KEY BENEFITS

- Synchronize Thousands of Client, Server & Workstation Clocks
- Very Reliable and Secure Source of Time for Your Network
- Multiple NTP Ports for Easy Network Configuration and Adaptation
- Extremely Accurate Time Source for Network Synchronization
- Enhanced Network & Security Features
- Improve Network Log File Accuracy to Speed Network Fault Diagnosis and Forensics
- Access Multiple Time Sources for Reliable and Secure Time
- Very Easy to Install and Maintain
- Intuitive Web Interface for Easy Control & Maintenance

Setting new standards for security, reliability, redundancy and versatility in network time servers, the SyncServer® S300 GPS Network Time Server is the solution for synchronizing the time on servers and workstations for large or expanding IT enterprises. Accurately synchronized clocks are critical for network log file accuracy, security, billing systems, electronic transactions, database integrity, VoIP, and many other essential applications.

The high performance S300 continues the SyncServer legacy of being the easiest to set up and maintain network time servers in the world. The front panel is designed to quickly bring the server online with a few front panel keystrokes or DHCP. To fully configure the unit, use the very intuitive web interface or the step-by-step web based wizards for the most common operations.

Once online, the S300 provides very reliable and secure network synchronization technology by combining multi-port network interfaces with multiple time reference technology and enhanced security protocols. Support of the essential security and network protocols provide for easy management and seamless integration into your existing and future network.

The S300 is the only time server available with a Gigabit Ethernet port plus three additional 10/100Base-T ports. This translates into high availability and throughput to support hundreds of thousands of network

clients while maintaining microsecond caliber NTP timestamp accuracy. These four completely independent ports provide the flexibility needed to easily adapt to different and changing network topologies and security requirements.

The Stratum 1 level S300 derives its extremely accurate time directly from the atomic clocks aboard the GPS satellite system. For redundancy and time assurance, the S300 also includes an internal modem to connect directly to legal time provided by national time authorities. Reliability is further enhanced via Stratum 2 operation by retrieving time from other user-designated time servers. An optional AM radio will synchronize to national time broadcasts, which can be an alternative to GPS when GPS is not a viable option.

To further protect against the loss of accurate time, the S300 can be upgraded to an internal Rubidium atomic oscillator that keeps the S300 accurate to microseconds per day.

The SyncServer S300 is your answer to bringing perfect timing to your network — securely, reliably and easily — and for many years to come.

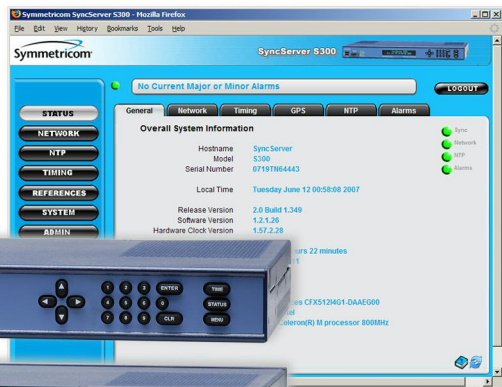

## S300 NETWORKING EXCELLENCE

### Gigabit Ethernet for Unmatched High Performance with Unparalleled Flexibility

The S300 has four dedicated and isolated Ethernet ports, one of which is Gigabit Ethernet. These are connected to a very high-speed microprocessor and a 50 nanosecond accurate clock to assure unparalleled high bandwidth NTP performance. This more than meets the need of servicing 7000 NTP requests per second while maintaining microsecond caliber timestamp accuracy.

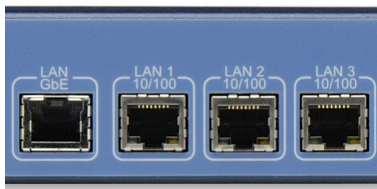

Four network ports (including Gigabit) provide network configuration flexibility and enhanced security. "Multiple" isolated and synchronized time servers can also be configured.

### Four Ports for Flexibility and Security

Multiple ports provide the flexibility to adapt to different network topologies as networks grow and change. An S300 can be the single time source to synchronize clients that are on different subnets and different physical networks. It is also an ideal solution for synchronized time on in-band and out-of band networks. Since each port is independent,

### BEST PRACTICES

- Always configure time clients to reference at least two time servers.
- Two time servers provide redundant time source protection for time clients.
- Peering between time servers assures time continuity to time clients if other time sources are not available.
- Increase network security by serving time via ports GbE, 2 and 3 and reserving port 1 for management only.

it can appear as though there are four clocks available, even though there is only a single time reference. In security sensitive networks we suggest using one port for maintenance and control functions and the other three ports for NTP timing functions only. This way the control port IP address information can be kept private and not distributed with the NTP addresses. IP address access control lists for each port also add enhanced security.

### Extensive Protocol Support for Secure and Easy Network Integration and Management

All of the expected network management and monitoring protocols are standard in the S300. Secure access protocols such as RADIUS, SSL, HTTPS, SSH, along with legacy protocols such as DHCP and Telnet are included to provide you a choice in server management. SNMP v3 with a custom MIB allows you to automatically monitor the S300 and be advised of any important status changes. Any of these protocols can be quickly and easily disabled via the web based management interface.

### Futureproof Your Network

The S300 supports both IPv4 and IPv6. The S300 works whether you are using IPv4, IPv4/IPv6 mixed-mode, or the IPv6 environment. This means your S300 can scale with your network operations and provide value for many years to come.

### Automatic Software Upgrade Availability Notification

The S300 can periodically check the Symmetricom web site for newer versions of firmware. If a newer version is available, an informational SNMP trap or email is sent along with a status message in the web interface.

### Point & Click Software Upgrades

Upgrading the firmware in the S300 is easy. Just browse to identify the firmware file and click the upload button. It is just as simple to backup and restore the server configuration files. This intuitive approach simplifies server management.

### Time Server Log Files

A running log of activity and server configuration changes is maintained for later reference.

## Examples of Network Timing Configurations

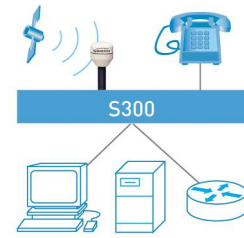

Basic configuration

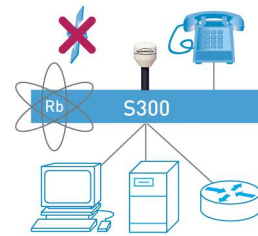

Resilient configuration incorporating a Rubidium Oscillator for improved holdover performance.

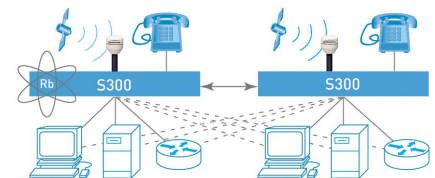

Redundant, resilient and secure configuration incorporating a Rubidium Oscillator in the primary server and peering to another server for backup redundancy.

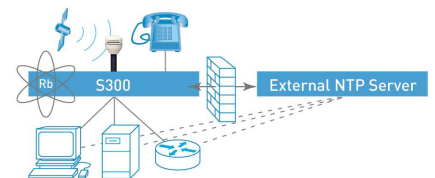

Resilient internal configuration. However, security, accuracy and reliability risks exist when peering with an external time server through the firewall.

### S300 ADVANCED AND FUNCTIONAL DESIGN

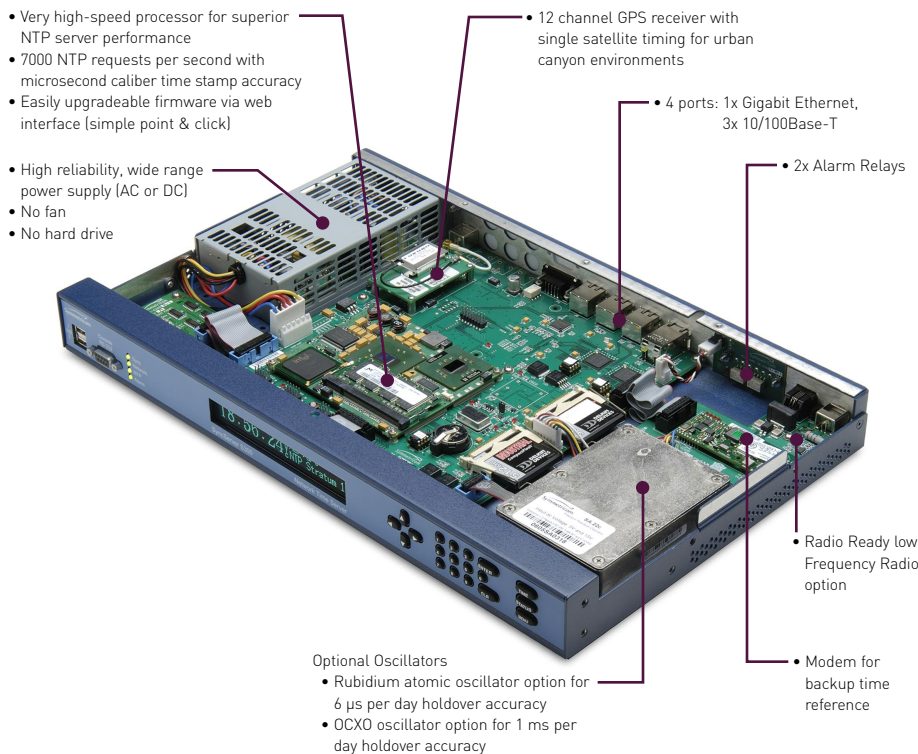

### Alarm Relays for Monitoring Systems

The S300 features in-depth internal monitoring, very flexible configurations, and external alarming. Alarm relays are one of several ways the unit can report alarm conditions to an alarm monitoring system. One relay is activated if power to the server is ever lost. The other relay is user configurable to activate if there is any major alarm, or any major/minor alarm.

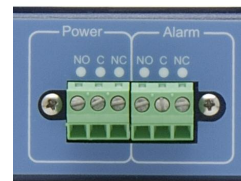

User configurable alarm relays for major/minor alarms as well loss-of-power alarm relay.



Crisp and bright vacuum fluorescent display offers high readability both near and far. Characters can be large, medium or small. Intensity is user adjustable.

### Control at Your Finger Tips

The interface on the S300 has been developed and tested from a user perspective. Keypad operation is quick and easy when using the full numeric keypad and control keys. You can cycle through different time formats by pressing the [TIME] key or get detailed status information by pressing the [STATUS] key. The S300 offers front panel menu control via the [MENU] button.

### Quick and Easy Installation

The S300 has been optimized for quick setup via the keypad, requiring a minimum number of keystrokes. Just enter the basic network parameters or select DHCP and the unit is online. Once online,



The full numeric keypad is the most efficient way to navigate a menu driven interface. The [TIME] & [STATUS] buttons quickly display the most critical information.

the web interface is the best and easiest way to customize the time server.

Primary configuration and management of the S300 is done via the intuitive and easy-to-use web interface. It is the first time server that offers wizards to streamline common setup and management tasks. No other time server is available with such an effortless interface that provides intuitive navigation and depth of control.

### Crisp, Bright Display and LEDs

Whether you need to view time information close-up or far away, the 256x32 high-resolution, variable intensity vacuum fluorescent display provides high visibility time and status in a variety of user selectable formats. The 1, 2 or 4 line display of data makes for a crystal clear time display along with an informative presentation of important configuration information. The four LEDs provide at-a-glance status of the current time reference, network connection status, NTP operational status and request activity, and any existing alarm situation.



Informative Status LEDs provide at-a-glance health of the network time server. The USB ports add additional flexibility in back-up, restore and upgrade operations.

### BEST PRACTICES

- A full numeric keypad with a display makes for quick initial setup and installation.
- Most interactions with a time server are remote and are best served with a full featured web interface and good SNMP monitoring.



## S300 FULL-FEATURED WEB INTERFACE

### Intuitive, Easy-to-Use and Secure

The S300 is designed to have the web interface be the primary status and control console. It is organized into logical groupings such as Status, Network, Timing, etc. The tabbed panels offer easy exploration of features and

point, want to perform with the server. These include initial set-up, configuring time source behaviors, back-up and restore operations, firmware upgrades, and more. The wizards make these operations very easy. Like all systems that include wizards, you can use the detailed configuration pages elsewhere in the web interface for custom configuration of the server.

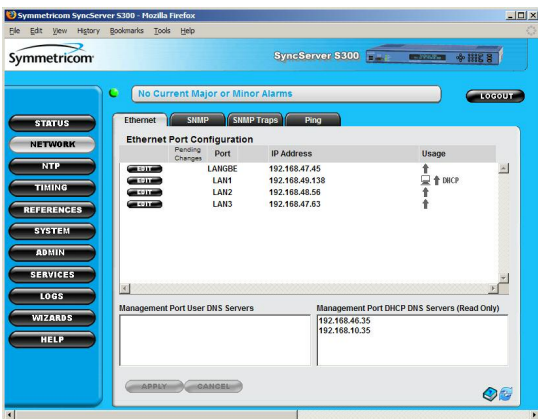
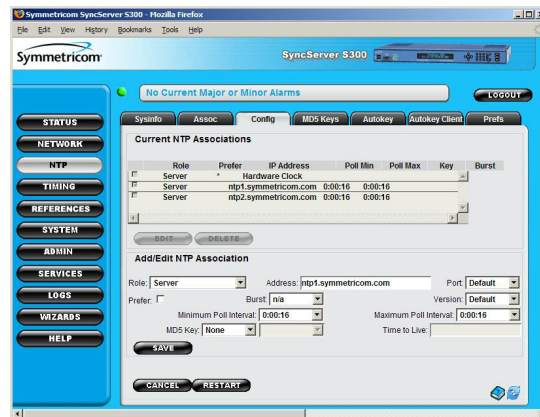

easy configuration of the server. Typical web interface conventions are followed so that operation is quickly mastered. Server access is password protected, with a choice of RADIUS authentication and SSL encryption for maximum security. The web interface is enabled only through Port 1 so that the user may choose to keep that port IP address exclusive and secure while serving time protocols only from Ports 2, 3 and/or GbE.

### Wizards Speed Routine Server Configuration Tasks

The S300 includes wizards to guide you step-by-step through the more frequent or expected operations. From experience we know there are certain configuration activities that most customers will, at some

### Built-in Help System

The complete S300 manual is built into the web interface. The manual opens in a separate browser window. It is organized to match the control buttons and tabs so that information is quickly and easily found. On most pages there is a link directly to the manual page for that panel.

In addition there are context sensitive rollover descriptors of various features and tabs on any given panel.

### Full System Status and Log Files

An essential part of a time server is knowing the system status when you need to. The S300 provides a semi-customizable green/red/orange light status with system messages for quick, at-a-glance information. Detailed status information is available on all of the major subsystems of the server via the

tabbed panels in the Status section. Any alarms or critical alerts are quickly found on the Alarm panel. To examine operational events, the Log section of the web interface provides detailed listings of System, NTP, SNMP, HTTP, and Event activities.

## BEST PRACTICES

- **Configuring a time server is generally done once and seldom repeated. For that reason it should be easy to configure and maintain.**
- **Consider the importance of quick and easy configuration back-up and restore operations, as well as the simplicity of firmware upgrades.**
- **Web based wizards save time and eliminate configuration conflicts. Easy configuration of advanced features is also important.**
- **Turning on the auto-notification of firmware update availability assures awareness of current firmware revisions.**

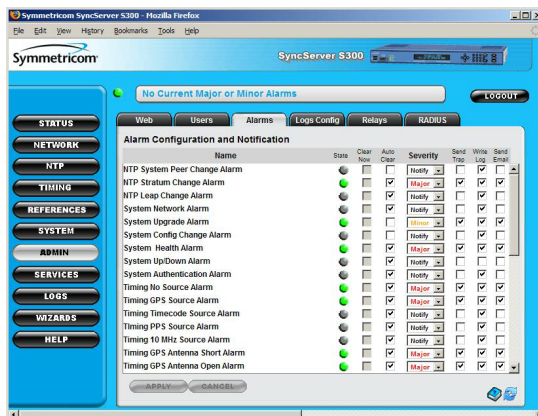

## S300 TIME SOURCE REDUNDANCY



### Synchronize to Legal Time Sources

Serving time and synchronizing computers with time that is legally traceable to a national time standard is a requirement for many organizations. The internal dial-up modem in the S300 and the optional AM radio both provide that direct path to a national time source, thus assuring compliance.



Internal modem and optional AM radio antenna provide access to national time sources for time reference redundancy.

### Multiple Time Sources Assure Reliable Time

The SyncServer S300 continually monitors multiple sources of time and synchronizes to the most reliable and accurate. The GPS satellites are the most accurate and widely available source of time, but not the only source. The S300 can use NTP peering to monitor the time of other time servers and the built-in modem can periodically dial national time services. In the event the GPS signals become unavailable, the S300 will immediately synchronize to the next best source of time. In all cases the network administrator is notified immediately of any change in time reference status.

### Improved Time Reliability with Different Access Paths

S300 time reliability starts with different paths to accurate time. Satellite, modem, and network provide redundancy should any one path become disconnected or unavailable. In addition, an optional AM radio provides a fourth path to time broadcasts in many areas including North America, Europe and Japan.

### Use Dial-Up or AM Radio when GPS is not an Option

Often a data center is located where GPS is not a viable option, such as a windowless basement of a tall building. The built-in modem on the S300 can provide dial-up access via analog phone line to the national time source maintained by many countries. Calls are made periodically and the frequency of the calls can be fixed or automatically optimized for accuracy. When used in conjunction with an optional OCXO or Rubidium oscillator, this solution offers a stable and reliable source of time for the network to rely on. Similarly, the optional AM radio can synchronize to national time broadcasts and works indoors or outdoors, anywhere or anytime the AM signal is detected.

### BEST PRACTICES

- NTP protocol experts advise that time servers should have at least two sources of time, three is better, and four or more is best.
- Dial-up and radio broadcast signals are also direct connections to legal sources of time.
- Access and availability of time should be a consideration in every network design.

### Synchronize to Legal Time via AM Radio

All SyncServer S300s are Radio Ready to accommodate an optional AM radio/antenna from Symmetricom. National time authorities in the USA, Europe and Japan (to name a few) all broadcast an AM time signal as an official source of time, and many common devices ranging from wall clocks to wristwatches synchronize to these broadcasts. The AM radio becomes an alternative source of time to GPS. Users can also prioritize the national radio signal ahead of the GPS signal as a time source and use GPS as a backup.

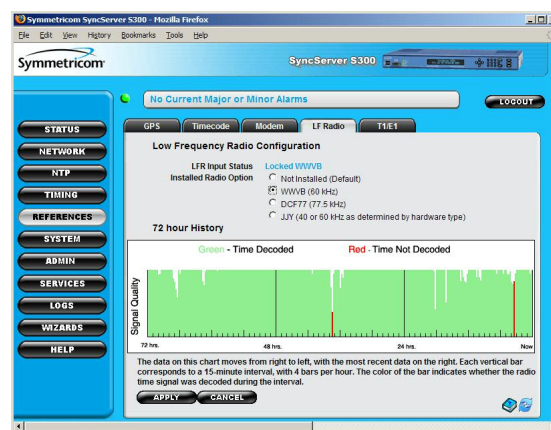

## S300 PERFECT TIMING

### Best-in-Class NTP Accuracy

The Stratum 1 level S300 derives nanosecond accurate time directly from the atomic clocks aboard the GPS satellite system. By using an integrated, 12-channel GPS receiver, every visible satellite can be tracked and used to maintain accurate and reliable time. Even in urban canyon environments where satellite visibility can be limited, single satellite tracking provides accurate time from as few as one intermittent satellite. If needed, the S300 can also track satellites using a window mounted antenna.

### Ultra High Performance NTP

The S300 can effortlessly support hundreds of thousands of network clients while maintaining microsecond caliber NTP timestamp accuracy. NTP request throughput rates exceed 7000 requests/second while maintaining NTP timestamp accuracy. This easily translates into 0.5-2 ms typical client synchronization accuracy on a LAN.

### Multiple References, Peering or Holdover

If the GPS reference signal is lost entirely, the S300 can automatically revert to alternate time sources and maintain Stratum 1, or drop to Stratum 2 mode and retrieve time from other user-designated internal or external

network time servers (called "peering"). This prevents disruption of time service to the network and the network administrator is notified immediately via SNMP of the change in time reference status. A popular adjunct to peering is letting the time server operate in holdover (also called "free run" or "flywheel") where the clock in the time server is allowed to drift if time sources are lost. The user can specify how far to let the clock drift in terms of estimated time accuracy before reverting to peering. If the optional Rubidium oscillator is installed, the S300 can flywheel for weeks and still be accurate to less than a millisecond.

### Time Cross-Checking for Peace of Mind Reliability

The S300 can time cross-check all reference time sources against at least two other time servers. This protects against an improperly operating GPS receiver or radio that can subtly corrupt the time.

### Flexible Control Over System Timing Inputs and Outputs

By protocol definition, the S300 serves NTP in the UTC timescale (or optionally in GPS timescale). However, the S300 can display local time rather than UTC on the front panel. The time can also be set manually with an override on the NTP alarms so that it behaves as though it is tracking a legitimate time source, even though it is actually in holdover.

### Sysplex Timer for Mainframe Sync

A dedicated Sysplex timer port outputs serial time strings for IBM mainframe Sysplex systems. The Sysplex Timer provides a common time reference across all the members of an IBM Sysplex. The Sysplex Timer is a key component when systems on multiple CPCs share access to the same data.



### Oscillator Upgrades Improve Holdover Accuracy and Save You Valuable Time

The standard S300 is equipped with a temperature compensated crystal oscillator (TCXO) that keeps the S300 accurate to nanoseconds when tracking GPS. However, if all time references are lost, thereby placing the server in holdover, the TCXO will soon drift away from perfect. Upgrading the oscillator improves the holdover accuracy significantly. For example, consider the drift rates below:

Oscillator	Holdover Drift
TCXO	18 milliseconds per day
OCXO	1 millisecond per day
Rubidium	6 microseconds per day

The value of the upgraded oscillator is that if the GPS signal is lost the S300 can continue to serve very accurate NTP time. This provides the IT staff plenty of time to correct the problem with no degradation or disruption in network time synchronization accuracy.

Accumulated Drift Error by Oscillator Type

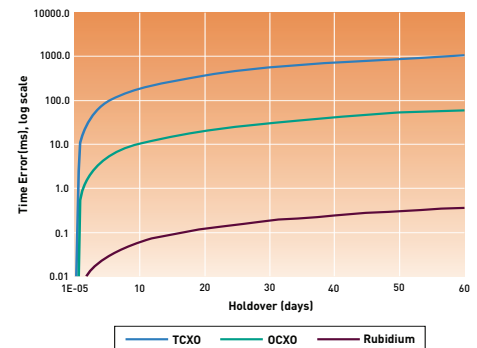

Plot of time error in milliseconds accumulated during holdover for different oscillator types. Note log scale of Y-axis.

## BEST PRACTICES

- Remember that accurate synchronization is directly related to how often the time clients update their time from the time server.
- Peering with other time servers is easy and provides a redundant source of time as a fallback.
- The optional Rubidium oscillator keeps the S300 extremely accurate while serving NTP in the event GPS service is interrupted.

### S300 UNRIVALED SECURITY

#### A Security Architecture

The S300 is carefully architected for security via the multiport configuration. The web based management interface is enabled only through Port 1 so that the administrator may choose to keep that port IP address private and secure. Only the time protocols can be served via Ports 2, 3 and/or GbE. Time protocols can also be served from Port 1.

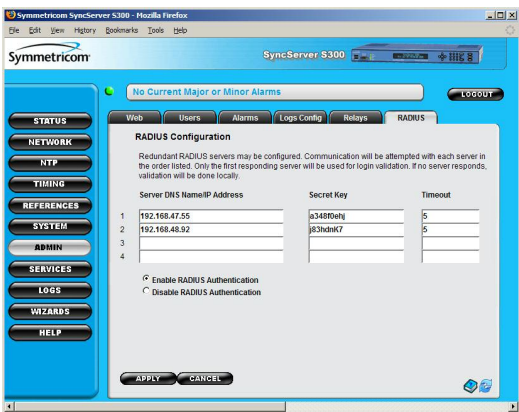

#### Management Access Security

Access to the web interface can be configured to pass through a variety of security measures including access control lists, passwords, RADIUS authentication, and SSL encryption for maximum security. RADIUS in particular provides excellent security and easy password management, particularly when there are multiple administrators that need access to the server. Individual protocols such as telnet, SSH, etc., can be disabled to further reduce open ports and running daemons in the server. Locally the keypad on the server can be password protected to prevent tampering.

#### User Access Security

Aside from configuring the multiple ports for different network segments, unique access control lists per port can govern server response to client requests for time.

#### Server/Client Authentication

Authentication is valuable to assure that time is being retrieved from the correct time server and not being spoofed in some way by an imposter or man-in-the-middle. The S300 supports the two NTP authentication protocols, MD5 and Autokey. Generally, authentication is used between critical time clients and the time server or between NTP peers across a WAN where trust is very important. MD5 symmetric key cryptography is reasonably easy to deploy between clients and servers and is used to verify NTP packet integrity. Symmetricon's state-of-the-art Autokey implementation is based on public key cryptography and is more sophisticated in its deployment. Autokey verifies both packet integrity and packet source using digital signatures. The S300 supports Autokey as a server and/or a client.

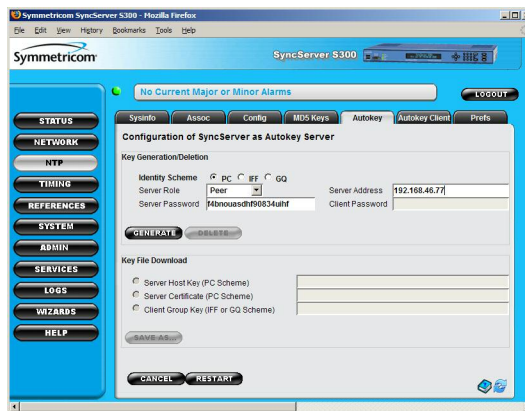

radio for the S300 synchronizes to the government maintained radio time broadcasts available across the U.S., Europe and Japan.

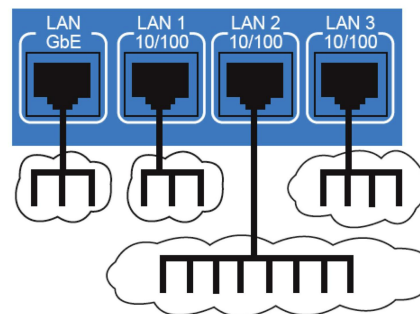

The Multiport configuration of the S300 with management on LAN 1 only is an excellent security measure and time distribution strategy.

#### Time Reference Security

The best way to assure the correct time is to have multiple, trusted time sources. The standard S300 supports satellite based GPS, dial-up modem access to national time sources such as NIST/ACTS, JJY, ITU-R TF583.4 and network peering to trusted time servers. The NTP daemon continuously evaluates all configured time sources and rejects outliers. In addition, the optional AM



### BEST PRACTICES

- Always change the factory set password. Use RADIUS authentication if available.
- Keep the management port IP address private or exclusive. Use the three other ports to serve time to the network at large.
- Use access control lists on one or more ports to block unauthorized IP addresses.
- Lockout front panel keypad access to prevent unauthorized changes.



# SyncServer S300 Specifications

## NETWORK PROTOCOLS

NTP (v2 - RFC1119, v3 - RFC1305, v4 - No RFC)	SNMP v1, v2c, v3 (RFC3584)
NTP Unicast, Broadcast, Multicast, Autokey	MIB II (RFC1213)
SNTP Simple Network Time Protocol (RFC2030)	DHCP (RFC2131)
TIME (RFC868)	Telnet (RFC854)
DAYTIME (RFC867)	MD5 Authentication (RFC1321)
HTTP/SSL/HTTPS (RFC2616)	RADIUS (RFC2865)
SSH/SCP (Internet Draft)	SMTP Forwarding
	IPv4, IPv6 and IPv4/IPv6 Hybrid

Key management protocols can be individually disabled.

LAN 1: Management & Time protocols; LAN 2, 3 & GbE: Time protocols only.

## SERVER PERFORMANCE

- 7000 NTP requests per second while maintaining accuracy associated with reference time source. The accuracy is inclusive of all NTP packet delays in and out of the SyncServer as measured at the network interface. Client synchronization accuracy to server on a LAN is 0.5 - 2 milliseconds (typical). The SyncServer easily supports many hundreds of thousands of NTP clients. NTP request handling capacity remains the same regardless of Stratum level.
- Stratum 1 via GPS: Overall time stamp accuracy of 7 microseconds to UTC with a variation of less than 42 microseconds typical
- Stratum 1 via Dial-up modem: <50 milliseconds to UTC (<20 ms typical).
- Stratum 2: Peering can be used as the primary mode of operation or as a back up mode in case the primary reference signals are lost. Time stamp accuracy depends on NTP peer server(s).
- Holdover Accuracy
  - TCXO (standard): 18 milliseconds/day
  - OCXO (optional): 1 milliseconds/day
  - Rubidium (optional): 6 microseconds/day

## GPS RECEIVER/ANTENNA

- 12 channel parallel receiver
- Minimum number of satellites for time: 1 intermittently
- GPS time traceable to UTC (USNO)
- Accuracy: <50 ns RMS, 150 ns peak to peak to UTC, ≥4 satellites tracked.
- Maximum Belden 9104 cable length: 150' (45 m). For longer cable runs see Options.

## INTERNAL ANALOG MODEM

- Telecom approved in more than 50 countries
- Time Encoding: ACTS, JJJ, and ITU-R TF583.4

## MECHANICAL/ENVIRONMENTAL

- Size: 1.75" x 17" x 11.25"  
(4.5 cm x 43.2 cm x 28.6 cm) 1U rack mount
- Power: 100-240 VAC, 50-60 Hz, 25 watts  
(45 watts with Rb osc.).
- Operating temperature: 0°C to +50°C
- Storage temperature: -10°C to +70°C
- Humidity: To 95%, noncondensing
- Certifications: FCC, CE (RoHS), UL, PSE, China RoHS
- Server weight: 9 lbs (4.1 kgs), Shipping package: 16 lbs (7.3 kgs)

## Front Panel

Display:	Sharp, high-resolution 32x256 dot-matrix vacuum-fluorescent. 1, 2 or 4 line.
Keypad:	0-9 numeric, up, down, left, right, ENTER, CLR, TIME, STATUS, MENU. Keypad lockout.
LEDs (tri-color green/red/orange)	
Sync:	Time reference status
Network:	Network connection status
NTP:	NTP activity
Alarm:	Fault condition
Serial:	DB9-F 9600, N, 8, 1
USB:	(2x) ports for back up, restore, and upgrade operations via the front panel.

## Rear Panel

Network (4x):	1x RJ-45 10Base-T/100Base-TX/1000Base-T Gigabit Ethernet 3x RJ-45 10Base-T/100Base-TX Ethernet Speed/Duplex: Auto, 10/full/half, 100/full/half DB9-M RS-232
Sysplex:	DB9-M RS-232
GPS:	BNC L1, 1575 MHz
Modem:	RJ-11 analog phone jack
Radio:	BNC, Optional antenna required for operation.
Power:	IEC 320 connector & power switch.
Relays:	2x, SPDT (Form C).

## CLIENT SOFTWARE

Included with the S300 is Symmetricom's SymmTime NTP client for Windows. See Options for comprehensive software solutions.

## PRODUCT INCLUDES

S300 Network Time Server, L1 GPS antenna, 50' (15 m) Belden 9104 coaxial cable, 1 ft. antenna mounting mast (30 cm) with two clamps, category 5 patch cable, DB9-M to DB9-F RS-232 extension cable, manual, SymmTime NTP client for Windows, Enterprise MIB software, power cord, and rack mount ear kit. Two-year warranty.

## OPTIONS

[See Options datasheet at [http://www.ntp-systems.com/pdf/DS\\_SSOpts.pdf](http://www.ntp-systems.com/pdf/DS_SSOpts.pdf)]

- Rubidium or OCXO oscillator upgrade for extended holdover
- AM Radio/Antenna (40, 60 or 77.5 kHz) for WWVB (USA), JJJ (Japan) or DCF77 (Europe)
- ±40-60 Vdc power supply
- Window mounted GPS antenna
- GPS antenna in-line amplifier for cable runs to 300' (90 m)
- GPS antenna down/up converter for cable runs to 1500' (457 m)
- Lightning arrestor
- Comprehensive time client, server & management software for easy distribution, management and monitoring of time across the network.
- NTP Network Time Displays, 2" or 4" (5 cm or 10 cm), 6 digit, red LEDs



Front View



Rear View



**SYMMETRICOM, INC.**  
2300 Orchard Parkway  
San Jose, California  
95131-1017  
tel: 408.433.0910  
fax: 408.428.7896  
info@symmetricom.com  
www.symmetricom.com